

Lista de Recambios / Spare part list

Nº Ident / Ident-no 003500100

Nombre / term EGA Relax



Cliente / customer

Proyecto / project

Fecha / stand October 2013



Lista de Recambios / Spare part list

Nº Ident / Ident-no 003500100

Nombre / term EGA Relax









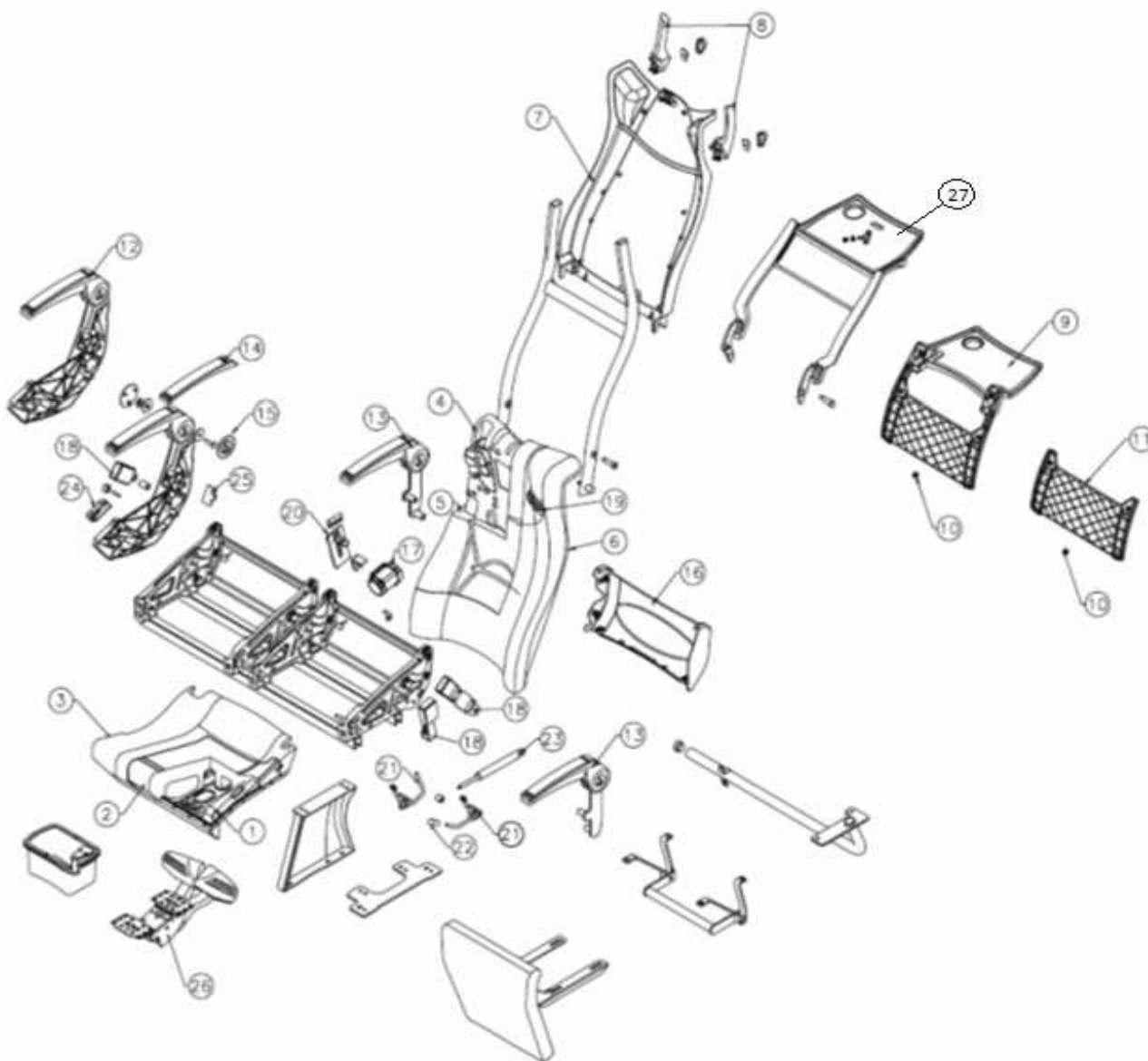









Cliente / customer

Proyecto / project













Fecha / stand October 2013









Nº	Referencia	Foto/Photo	Denominación	Description	Comentarios/Remarks
Nr	Part no.				
1	003540403-N50		Fondo cojin	Cushion pan	
2	003510401		Espuma cojin	Cushion foam	
3.1	003504400-CFG		Cojin tapizado pasillo	Aisle trimmed cushion	Facilitar nº obra y posicion / Body number and position is required
3.2	003504410-CFG		Cojin tapizado ventana	Window trimmed cushion	Facilitar nº obra y posicion / Body number and position is required
4	003540402-N50		Fondo respaldo	Backrest squab	
5	003510301		Espuma respaldo	Backrest Foam	
6.1	003504300-CFG		Respaldo tapizado pasillo	Aisle trimmed backrest	Facilitar nº obra y posicion / Body number and position is required
6.2	003504310-CFG		Respaldo tapizado ventana	Window trimmed backrest	Facilitar nº obra y posicion / Body number and position is required
7.1	003540410-G21		Carcasa de respaldo para asas sin accesorios	Backrest shell without accesories	
7.2	003507830-G21		Carcasa de respaldo para asas con revistero	Backrest shell with net magazine	
7.3	003507831-G21		Carcasa de respaldo para asas con revistero y mesita	Backrest shell with net magazine and table	
7.4	003507810-002		Carcasa de respaldo <u>portaobjetos</u> para asas sin accesorios	Storage tray backrest shell without accesories	

Nº	Referencia	Foto/Photo	Denominación	Description	Comentarios/Remarks
Nr	Part no.				
7.5	003507833-G21		Carcasa de respaldo <u>portaobjetos</u> para asas con revistero	Storage tray backrest shell with net magazine	
7.6	003507834-G21		Carcasa de respaldo <u>portaobjetos</u> para asas con revistero y mesita	Storage tray backrest shell with net magazine and table	
8.1	003540405G26-KIT		Asas de respaldo	Backrest handle	
8.2	003540407G26-KIT		Tapones asidero	Handle cover	El kit consta de 5 tapas izdas y 5 dchas/ Every kit has 5 left handle cover and 5 right handle cover
9	003507821-KIT		Mesita con revistero	Table and magazine net	
10	003540901-G26		Clip fijacion revistero	Magazine net clip	Lote mínimo/Minimun batch: 50 un.
11.1	003507301-KIT		Revistero	Magazine net	
11.2	003507835		Revistero mesita independiente	Independent table magazine	
12.1	003504200-001		Lateral izdo	Left lateral	
12.2	003504200-002		Lateral dcho	Right lateral	
13.1	003507220-001		Apoyabrazos costado o central izdo	Left bodyside complet armrest	
13.2	003507220-002		Apoyabrazos costado o central dcho	Right bodyside complet armrest	

Nº	Referencia	Foto/Photo	Denominación	Description	Comentarios/Remarks
Nr	Part no.				
13.3	003507220-003		Apoyabrazos costado o central izdo fijo	Left bodyside complet armrest fixed	
13.4	003507220-004		Apoyabrazos costado o central dcho fijo	Right bodyside complet armrest fixed	
14	003540201G21-KIT		Almohadilla con tapas	Armrest covers	
15	002546201-KIT		Kit giro apoyabrazos	Armrest turn mechanism	
16.1	003543403-G21		Rodapie izdo	Left kick plate	
16.2	003543404-G21		Rodapie dcho	Right kick plate	
16.3	003543405-G21		Rodapie 2 brazos	2 Armrest kick plate	
17.1	000699846		Carrete cinturon 2P asiento izquierdo	2P belt for left seat	Marca gris
17.2	000699847		Carrete cinturon 2P asiento dcho	2P belt for right seat	Marca lila
17.3	000699848		Carrete cinturon 3P asiento derecho	3P belt for right seat	Marca gris
17.4	000699849		Carrete cinturon 3P asiento izdo	3P belt for left seat	Marca lila
18.1	000699926		Hebilla pasillo 2P & 3P	Aisle buckle 2P & 3P	

Nº	Referencia	Foto/Photo	Denominación	Description	Comentarios/Remarks
Nr	Part no.				
18.2	000699928		Hebilla ventana 2P & 3P	Window buckle 2P & 3P	
18.3	000699920		Hebilla butaca trasera	Rear seat buckle	
19	002540723-KIT		Guia exterior cinta	Belt outside guide	
20	003540706N50-KIT		Guia cinta	Belt guide	
21.1	003502001		Montaje mecanismo reclinacion izda	Left side reclining lever	
21.2	003502002		Montaje mecanismo reclinacion dcha	Right side reclining lever	
21.3	003502003		Montaje mecanismo reclinacion traseras izda	Rear seats - left side reclining lever	
21.4	003502004		Montaje mecanismo reclinacion traseras dcha	Rear seats - right side reclining lever	
22	000040402		Pomo reclinacion costado	Side recline knob	Antes/Before October 2013: Reference : 008140415. Lote mínimo/Minimun batch: 25 un.
23	000699316		Resorte gas	Gas ram	
24.1	003540301R05-KIT		Pulsadores reclinacion	Reclining buttons	Antes Octubre 2013 pulsadores con serigrafia/ Before October 2013 buttons with arrows.
24.2	003566403R05-KIT		Pulsadores reclinacion con desplazable	Reclining and sliding buttons	

Nº	Referencia	Foto/Photo	Denominación	Description	Comentarios/Remarks
Nr	Part no.				
24.3	003540301G26-KIT		Pulsadores sin serigrafiar grises	Grey buttons not printed	
25	003520303G14-KIT		Tapa hueco hebilla	Buckle hole cover	
26.1	003502507-KIT		Apoyapies R 2 posiciones	2 position footrest	
26.2	003502508-KIT		Apoyapies R 4 posiciones	4 position footrest	
27	003507822		Mesita independiente "tipo avión"	Independent table "plane type"	
A	000699703-G20		Posavasos gris	Grey cup holder	
B	000699437		Percherito retráctil	Retractable hook	