

Lista de Recambios / Spare part list

Nº Ident / Ident-no 006600110

Nombre / term CIVIC V3



Cliente / customer

Proyecto / project

Fecha / stand November 2013



Lista de Recambios / Spare part list

Nº Ident / Ident-no 006600110

Nombre / term CIVIC V3









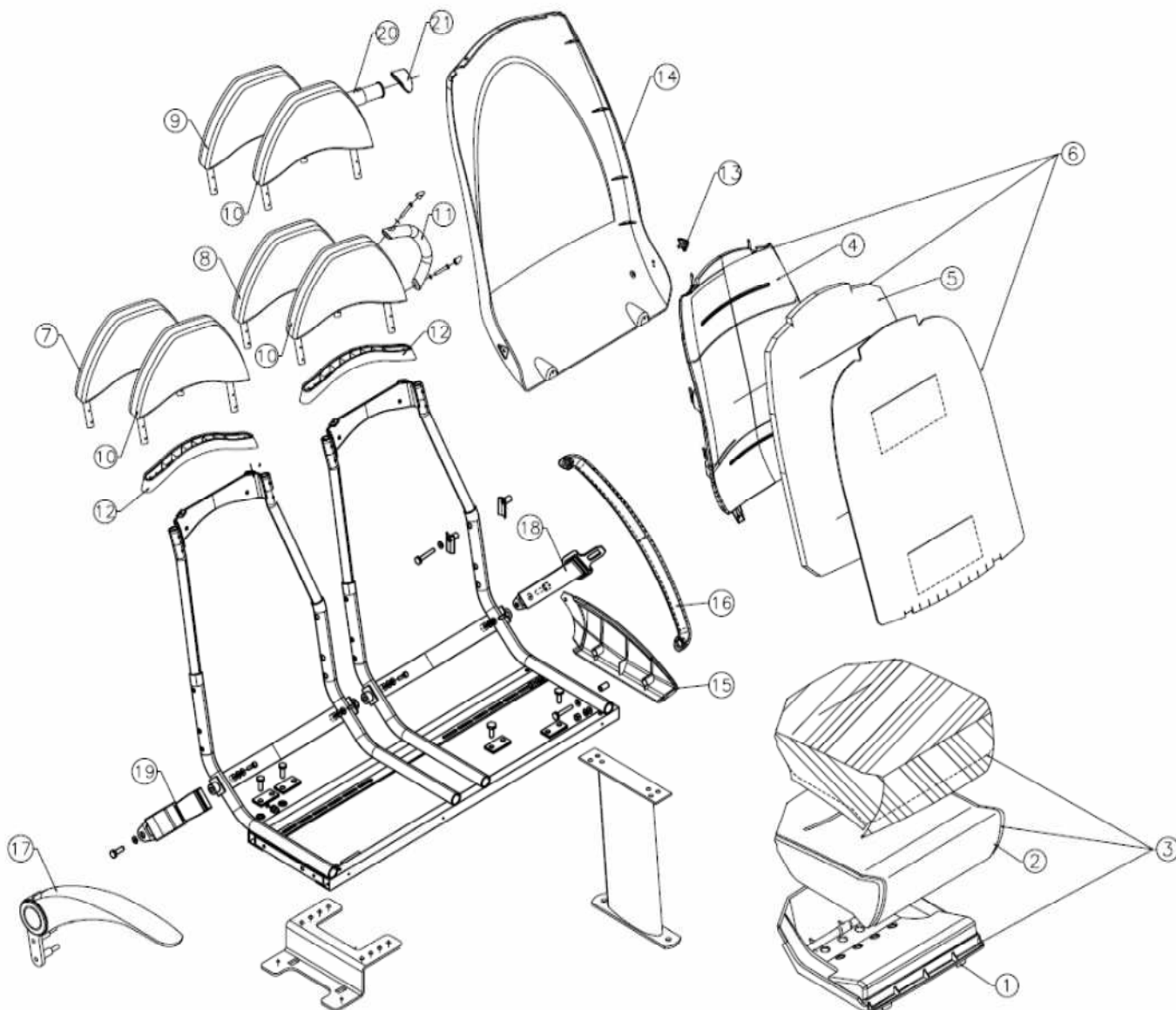













Cliente / customer







Proyecto / project

Fecha / stand November 2013



Nº	Referencia	Foto/Photo	Denominación	Description	Comentarios/Remarks
Nr	Part no.				
1.1	006640405		Fondo cojin	Cushion pan	
1.2	006640449		Fondo cojin para cinturon 2P izquierdo	Cushion pan for 2P left belt	
1.3	006640450		Fondo cojin para cinturon 2P derecho	Cushion pan for 2P right belt	
2	006610402		Espuma cojin	Cushion foam	
3	0066044XX		Cojin tapizado	Trimmed cushion	Facilitar nº obra y posicion / Body number and position is required
4	006640451		Fondo respaldo	Backrest squab	
5	006611303		Espuma respaldo	Backrest Foam	
6	0066043XX		Respaldo tapizado	Trimmed backrest	Facilitar nº obra y posicion / Body number and position is required
7	006610503		Cabezal sin tapizar sin asa	Headrest without handle	
8.1	006610531		Cabezal sin tapizar con asa izda	Headrest with left handle	
8.2	006610532		Cabezal sin tapizar con asa dcha	Headrest with right handle	
9.1	006602501	Not photo	Cabezal sin tapizar con brida 33 mm izda	Headrest with left hanpole connector 33mm	
9.2	006602502	Not photo	Cabezal sin tapizar con brida 33 mm dcha	Headrest with right hanpole connector 33mm	

Nº	Referencia	Foto/Photo	Denominación	Description	Comentarios/Remarks
Nr	Part no.				
9.3	006602503	Not photo	Cabezal sin tapizar con brida 35 mm izda	Headrest with left hanpole connector 35mm	
9.4	006602504	Not photo	Cabezal sin tapizar con brida 35 mm dcha	Headrest with right hanpole connector 35mm	
10	0066045XX		Cabezal tapizado	Trimmed headrest	Facilitar nº obra y posicion del asa o brida / Body number and handle or handpole conector position is required
11.1	0066404135N50-KIT		Asa cabezal negra	Black headrest handle	
11.2	0066404135A01-KIT		Asa cabezal amarilla	Yellow headrest handle	
12	006640417		Embellecedor cabezal	Headrest trimming	
13	006640901		Triangulo logotipo	Logo triangle	Lote mínimo/Minimun batch: 10 un.
14	006640402-G07		Carcasa Respaldo	Backrest shell	
15.1	006640403-G07		Cacha lateral izda	Left side cover	
15.2	006640404-G07		Cacha lateral dcha	Right side cover	
16.1	006602201		Brazo codera izdo	Left hip restraint	
16.2	006602202		Brazo codera dcho	Right hip restraint	

Nº	Referencia	Foto/Photo	Denominación	Description	Comentarios/Remarks
Nr	Part no.				
17.1	006607208		Brazo elevable completo dcho	Right foldable armrest	
17.2	006607209		Brazo elevable completo izdo	Left foldable armrest	
18	000699855		Carrete cinturon	Seat Belt	
19	000699920		Hebilla cinturon	Seat Buckle	
20.1	000699003		Soporte Brida 33mm	Handpole connector 33mm	
20.1	000699004		Soporte Brida 35mm	Handpole connector 35mm	
21	006640004-N50		Tapa cabezal brida barra	Headrest tap for handpole connector	