

Lista de Recambios / Spare part list

Nº Ident / Ident-no 006600110

Nombre / term CIVIC V2



Cliente / customer

Proyecto / project

Fecha / stand November 2013



Lista de Recambios / Spare part list

Nº Ident / Ident-no 006600110

Nombre / term CIVIC V2









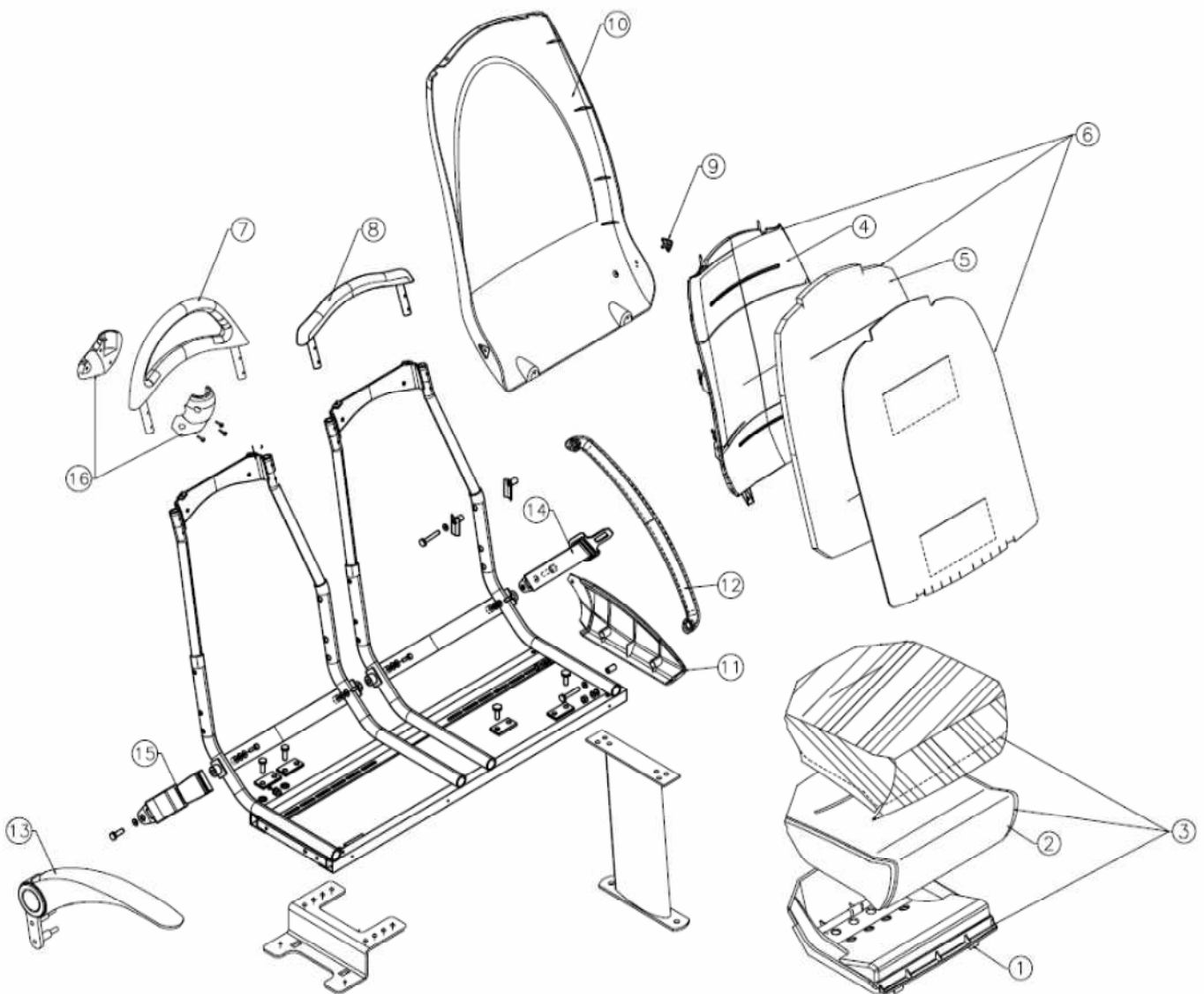









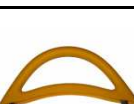

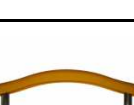



Cliente / customer



Proyecto / project

Fecha / stand November 2013



Nº	Referencia	Foto/Photo	Denominación	Description	Comentarios/Remarks
Nr	Part no.				
1.1	006640405		Fondo cojin	Cushion pan	
1.2	006640449		Fondo cojin para cinturon 2P izquierdo	Cushion pan for 2P left belt	
1.3	006640450		Fondo cojin para cinturon 2P derecho	Cushion pan for 2P right belt	
2	006610402		Espuma cojin	Cushion foam	
3	0066044XX		Cojin tapizado	Trimmed cushion	Facilitar nº obra y posicion / Body number and position is required
4	006640451		Fondo respaldo	Backrest squab	
5	006611303		Espuma respaldo	Backrest Foam	
6	0066043XX		Respaldo tapizado	Trimmed backrest	Facilitar nº obra y posicion / Body number and position is required
7.1	006640002-N50		Asidero negro	Black top handle	
7.2	006640002-A01		Asidero amarillo	Yellow top handle	
8.1	006640003-N50		Montera negra	Black cap cover	
8.2	006640003-A01		Montera amarilla	Yellow cap cover	

Nº	Referencia	Foto/Photo	Denominación	Description	Comentarios/Remarks
Nr	Part no.				
9	006640901		Triangulo logotipo	Logo triangle	Lote mínimo/Minimum batch: 10 un.
10	006640402-G07		Carcasa Respaldo	Backrest shell	
11.1	006640403-G07		Cacha lateral izda	Left side cover	
11.2	006640404-G07		Cacha lateral dcha	Right side cover	
12.1	006602201		Brazo codera izdo	Left hip restraint	
12.2	006602202		Brazo codera dcho	Right hip restraint	
13.1	006607208		Brazo elevable completo dcho	Right foldable armrest	
13.2	006607209		Brazo elevable completo izdo	Left foldable armrest	
14	000699855		Carrete cinturon	Seat Belt	
15	000699920		Hebilla cinturon	Seat Buckle	
16.1	006606003		Brida izda 35mm	Left handpole connector 35mm	
16.2	006606004		Brida dcha 35mm	Right handpole connector 35mm	

Nº	Referencia	Foto/Photo	Denominación	Description	Comentarios/Remarks
Nr	Part no.				
16.3	006606005		Brida izda 33mm	Left handpole connector 33mm	
16.4	006606006		Brida dcha 33mm	Right handpole connector 33mm	