

## Lista de Recambios / Spare part list

**Nº Ident / Ident-no** 008500150

**Nombre / term** Irati Trip

**Cliente / customer**

**Proyecto / project**

**Fecha / stand** March 2015



# Lista de Recambios / Spare part list

Nº Ident / Ident-no 008500150

Nombre / term Irati Trip









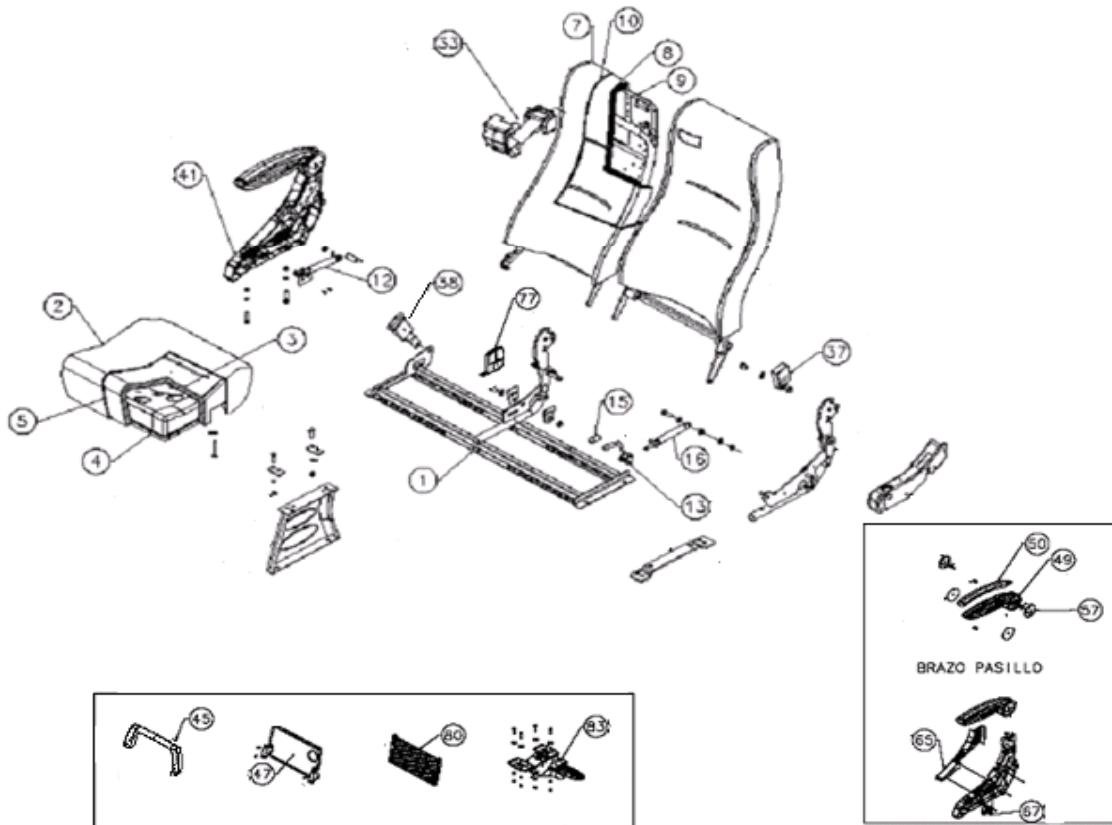



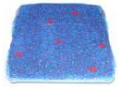





Cliente / customer













Proyecto / project







Fecha / stand March 2015



Nº	Referencia	Foto/Photo	Denominación	Description	Comentarios/Remarks
Nr	Part no.				
1	0085011600N50-CFG		Bastidor	Frame	Facilitar nº obra y posicion / Body number and position is required
2.1	0085044600-CFG		Cojin tapizado pasillo	Aisle trimmed cushion	Facilitar nº obra y posicion / Body number and position is required
2.2	0085044610-CFG		Cojin tapizado ventana	Window trimmed cushion	Facilitar nº obra y posicion / Body number and position is required
3	008510401		Espuma de cojin	Cushion foam	
4	008540401		Carcasa de cojin	Cushion pan	
5.1	0085034600-CFG	Not photo	Funda cojin pasillo	Aisle cover cushion	Facilitar nº obra y posicion / Body number and position is required
5.2	0085034620-CFG	Not photo	Funda cojin ventana	Window cover cushion	Facilitar nº obra y posicion / Body number and position is required
7.1	0085043600-CFG		Respaldo tapizado pasillo	Aisle trimmed backrest	Facilitar nº obra y posicion / Body number and position is required
7.2	0085043610-CFG		Respaldo tapizado ventana	Window trimmed backrest	Facilitar nº obra y posicion / Body number and position is required
8.1	006110310	Not photo	Espuma respaldo 2 puntos	Backrest foam for 2 points belt	
8.2	009811302	Not photo	Espuma respaldo 3 puntos derecha	Right backrest foam for 3 points belt	
8.3	009811301	Not photo	Espuma respaldo 3 puntos izquierda	Left backrest foam for 3 points belt	

Nº	Referencia	Foto/Photo	Denominación	Description	Comentarios/Remarks
Nr	Part no.				
9.1	0085013600N50-CFG	Not photo	Armadura respaldo pasillo	Aisle backrest frame	Facilitar nº obra y posicion / Body number and position is required
9.2	0085013610N50-CFG	Not photo	Armadura respaldo ventana	Window backrest frame	Facilitar nº obra y posicion / Body number and position is required
10	0085033600-CFG	Not photo	Funda respaldo	Backrest cover	Facilitar nº obra y posicion / Body number and position is required
12	008506101		Kit mecanismo reclinacion pasillo	Aisle reclining kit	
13.1	002104004		Montaje reclinacion costado derecha	Right side reclining lever	
13.2	002104005		Montaje reclinacion costado izquierda	Left side reclining lever	
15	000040402		Pomo reclinacion costado	Side recline knob	
16	000699302		Resorte 500 N	Gas ram	
33.1	000699835		Carrete 2 puntos	2P belt	
33.2	000699858		Carrete 3 puntos	3P belt	
37	000699907		Hebilla ventana	Window buckle	
38	000699913		Hebilla pasillo	Aisle buckle	

Nº	Referencia	Foto/Photo	Denominación	Description	Comentarios/Remarks
Nr	Part no.				
41.1	0085042630-001		Lateral izquierdo M-G14 ; P-G21	Left lateral M-G14 ; P-G21	
41.2	0085042630-002		Lateral derecho M-G14 ; P-G21	Right lateral M-G14 ; P-G21	
45	008505605		Montaje asidero	Handle kit	Solo asidero/only handle: 000699434-G21
47.1	008507813		Montaje mesita gris	Table kit grey	Solo mesita/only table: 000699722-G21
47.2	008507807		Montaje mesita negra	Table kit black	Solo mesita/only table: 000699722-N50
49	008547201-G14		Cuerpo apoyabrazos	Armrest body	
50	008540201-G21		Almohadilla apoyabrazos	Armrest pillow	Antes/Before 2014: 008540201-G27
57	008540414-G21		Tapa apoyabrazos	Armrest cover	Antes/Before 2014: 008540414-G27
65.1	008540402-G21		Embelledor lateral derecho	Right lateral tailpipe	Antes/Before 2014: 008540402-G27
65.2	008540404-G21		Embelledor lateral para hebilla derecho	Right lateral tailpipe for buckle	Antes/Before 2014: 008540404-G27
65.3	008540403-G21		Embelledor lateral izquierdo	Left lateral tailpipe	Antes/Before 2014: 008540403-G27
65.4	008540405-G21		Embelledor lateral para hebilla izquierdo	Left lateral tailpipe for buckle	Antes/Before 2014: 008540405-G27

Nº	Referencia	Foto/Photo	Denominación	Description	Comentarios/Remarks
Nr	Part no.				
67.1	008566401		Pomo inclinacion izquierdo	Left reclining pommel	
67.2	008566402		Pomo inclinacion derecho	Right reclining pommel	
77	008540701		Guia cinta doble	Double belt guide	
80.1	008507301		Montaje revistero gris	Magazine kit grey	Solo revistero/ only magazine: 000699727-G21
80.2	002107303		Montaje revistero negro	Magazine kit black	Solo revistero/ only magazine: 000699712-N50
83.1	008507610-CFG		Kit apoyapiés pasillo 4 posiciones	4 position aisle footrest	Solo apoyapiés/ only footrest: 000002511
83.2	008507620-CFG		Kit apoyapiés ventana 4 posiciones	4 position window footrest	Solo apoyapiés/ only footrest: 000002511
A.1	004005602	Not photo	Kit asa lateral amarilla	Yellow lateral handle kit	
A.2	004005604	Not photo	Kit asa lateral negra	Black lateral handle kit	